

X-SERIES | 10x10

SETUP INSTRUCTIONS



THANK YOU FOR PURCHASING A 10x10 | X-SERIES TENT!

If you have questions about installation, maintenance, or take down, please call us at (800)950-4553. Our goal is that you are completely satisfied with our products. Please read this installation manual carefully and follow all instructions contained herein. Please note that the installer is responsible for the site selection, installation and use. Do not erect during inclement weather and follow all safety procedures during the installation and take down process.

Please contact all utility companies for underground services. In many states, the utilities work together and have formed a Utility Locating Service. It is your responsibility to locate all the underground services, including speaking to the owner about irrigation, pool and other special services that they may have installed. Also, please note that special precautions should be taken such that any overhead powerlines are duly noted and avoided during the tent erection process.

To provide the quickest possible service, please fill in the information below so that we may effectively help you should a problem arise.

MODEL	SIZE	JOB NUMBER
<input type="text"/>	<input type="text"/>	<input type="text"/>
<input type="text"/>	<input type="text"/>	<input type="text"/>
<input type="text"/>	<input type="text"/>	<input type="text"/>



TentCraft Inc in no way represents the estimated holding power to be true in all cases. It is an estimate, and as such, does not imply that the figures are sufficient to hold any tent securely in windy or adverse weather conditions. The tent installer accepts sole responsibility for the safe installation, teardown, and maintenance of any tent. TentCraft does not represent in any way that the materials provided with the purchase of the tent are sufficient enough to hold it up in windy or adverse weather conditions. There is no way for TentCraft to know the site conditions or the weather conditions at the event to be able to recommend the adequate amount of holding power needed to hold the tent safely in position. Furthermore, we are not responsible for the methods which the installer uses to erect the tent or anchor it in position. Installers **MUST** be empowered to deem the tent unsafe for occupancy if/when the weather becomes unstable. For further recommendations on determining necessary staking values, please consult the IFAI Procedural Handbook for the Safe Installation and Maintenance of Tentage and the IFAI's Pullout Capacity of Tent Stakes. These resources are available from the IFAI Tent Rental Division.

HERE'S WHAT YOU'RE WORKIN' WITH...



Qty: 4 - 7' Legs (82")



Qty: 1 - Crown Cluster

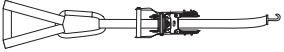

Qty: 4 - Tent Top Straps



Qty: 4 - Perimeter Poles (112") ●



Qty: 4 - Corner Brackets



Qty: 4 - OutGuy Straps



Qty: 4 - Hip Poles (82") ●



Qty: 4 - 3' Stakes

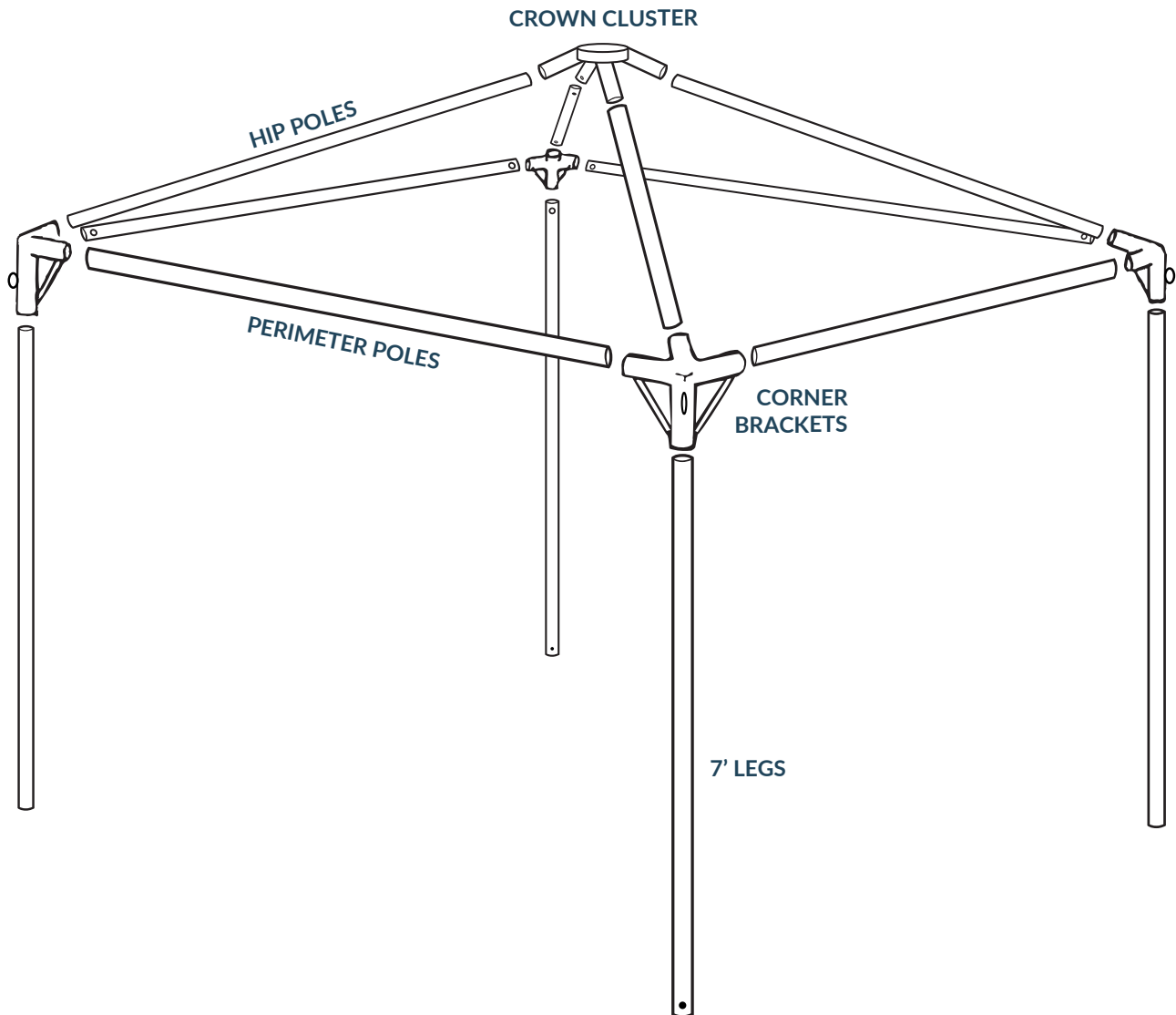

Step 1

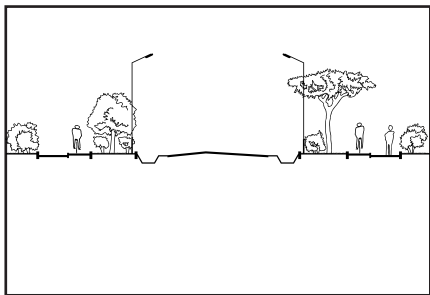

Inspect the tent site thoroughly for obstacles, underground and overhead wires, pipes, etc. If necessary, consult with your local utility company prior to installation.

Step 2

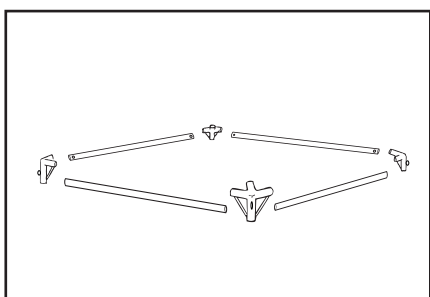

Lay out the erection site by first placing the corner brackets and perimeter poles in sequence per the diagram to the left for assembly. Do not install legs or roof rafters at this time.

Step 3

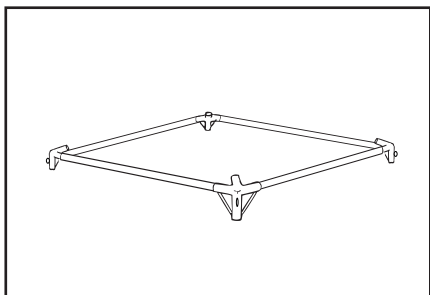

Begin assembly of the frame by inserting the perimeter poles into the corner brackets and ensure that the snap pins lock into place.

Step 4

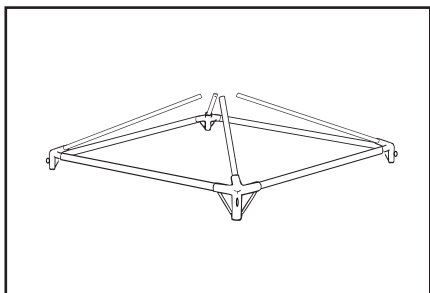

Insert hip poles into corner brackets at all four corners and ensure that the snap pins lock into place. All four poles should be installed with the open hole end towards the sky and the snap pin ends towards the ground. Ensure that all snap pins lock into place in all brackets.

Step 5

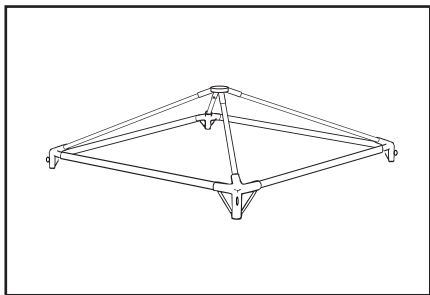

Install the crown cluster bracket by inserting a hip pole first - and then inserting one pole at a time, clockwise around the bracket. It may be necessary to lift up on the cluster to get the poles installed and locked into place.

Step 6

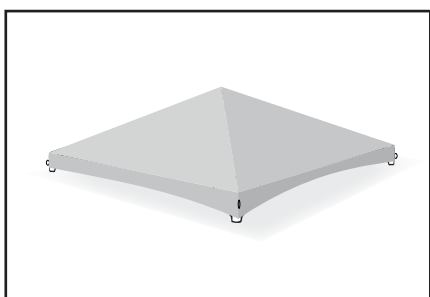

Lay the top over the frame and pull over the peak. Ensure that the corners of the top align with the corner brackets.

Step 7

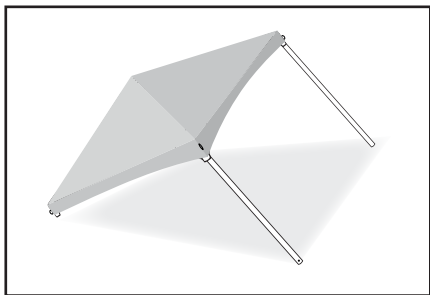

Lift one side of the frame and install the legs along that side.

Step 8

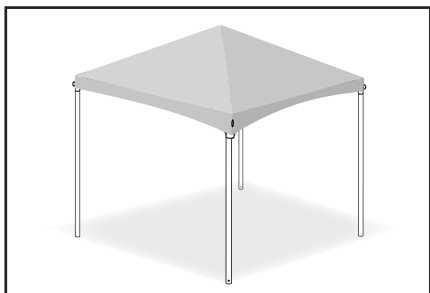

Lift the opposite side of the tent and insert the legs into the corner brackets as in the previous step.

Step 9

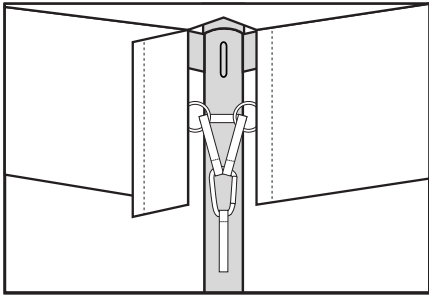

Attach tent top to the frame with the tent top straps. Bring the “Y” straps (located at the very top of the tent top straps) through the metal rings on each of the tent top valances and secure the looped ends of the “Y” straps into the carabiner. Fold the valance flap over the “Y” straps where the strips of velcro line up to finish the corner. Repeat this step at the remaining 3 corners. ****Do not hook carabiner directly to metal valance rings!****

Step 10

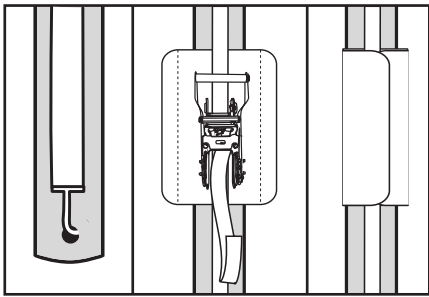

Attach the bottom of the tent top straps to the legs of the tent by inserting the hook into the hole at the bottom of the leg poles. Locate the ratchet in the middle of the strap and tighten until the strap is taut enough to secure the canopy. Repeat this step at the remaining 3 corner legs.

Once the top is secured on all corners, fold all extra strap length into the white vinyl covers with velcro closure.

Step 11

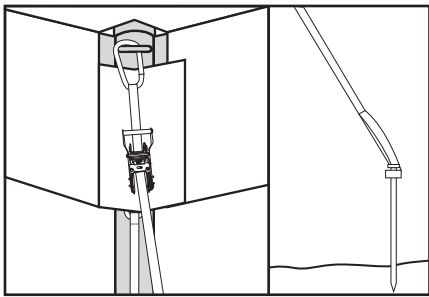

Locate the outguy straps and connect the carabiner at the top of the strap to the cast eyelet that is on the outside of each of the corner brackets. Locate the 3' ground stakes and wrap the looped strap (found at the bottom end of the outguy straps) around the head of the stake twice. Drive the stakes into the ground 5' out from each corner leg and ratchet the strap until it is taut. Repeat this step on the three remaining corner legs.

Step 12

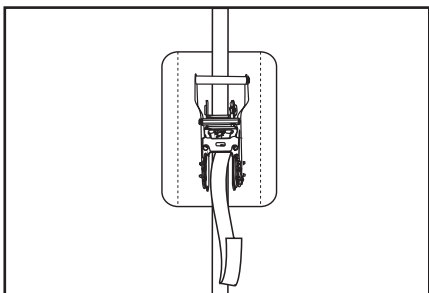

Once all stakes have been secured and straps ratcheted taut, fold all extra outguy strap length into the white vinyl covers with velcro closure.

Anchoring Requirements (Non-Certified Tents)

Non-certified tents are not engineered to meet specific wind loads. Wind loads are approximate and are generally rule of thumb calculations used in the industry based on actual field experience. Windload of a non-certified tent will vary to a maximum of approximately 30 to 50 mph dependent upon the style of type of tent. The structural integrity of the tent may exceed the soil's holding capacity even at wind loads of 30 to 50 mph.

Frame tents require approximately 1000 to 2000 lbs of holding power per anchor location (dependent on the size and style of the tent). For safety of all occupants, evacuation is recommended if weather becomes severe.

Severe storms have micro bursts of wind that may be recorded far in excess of the storm's highest winds. The installer is responsible for properly securing the temporary structure (tent). Soil conditions will vary and the wind loads that the temporary structure can handle could be significantly below its wind load capabilities.

Tent Size	Square Footage	Anchor Power Required	Safety Factor	Anchor Locations	Holding Power Required at Each Anchor Location
10' x 10'	100	960	1.5	4	240*

*Holding power is based on firm soil conditions. If other conditions prevail, the holding power will decrease and alternate anchoring methods are required.



Note: The tent must be anchored properly for safe installation. Additional guys and stakes may be required depending on soil and/or wind conditions. Refer to the IFAI Procedural Handbook for Safe Installation and Maintenance of Tentage for calculating the proper anchoring capacity for soil and or ground conditions. Always follow manufacturer's recommended anchoring techniques.

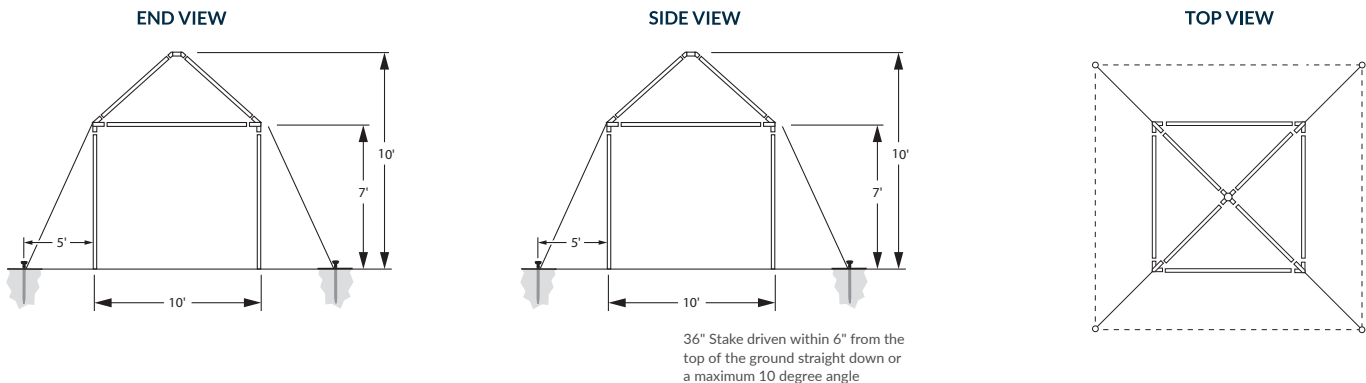

Guy Data:
1" Polyester Web - 3600 # rating*

- *ASSUMES:
1. Surface: Compacted soil
 2. Standard pull-out rate 800 lb/sq ft.
 3. Normal staking configuration/conditions